

## SMCJ200CA SURFACE MOUNT TRANSIENT VOLTAGE SUPPRESSOR

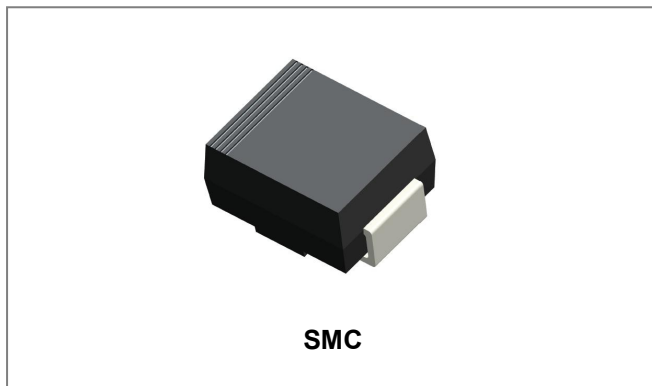

### Features

- Glass Passivated Die Construction
- 1500W Peak Pulse Power Dissipation
- Bi-Directional Versions Available
- Excellent Clamping Capability
- Fast Response Time
- Plastic Case Material has UL Flammability Classification Rating 94V-0
- “-A” is an AEC-Q101 qualified device
- This is a Pb – Free Device
- All SMC Parts are Traceable to the Wafer Lot
- Additional testing can be offered upon request

### Circuit Diagram



Bipolar

### Mechanical Data

- Case: SMC Low Profile Molded Plastic
- Terminals: Solder Plated , Solderable per MIL-STD 750, Method 2026
- Polarity: Color band denotes cathode except Bipolar
- Mounting Position: Any
- Weight:0.21grams(approx.)

### Maximum Ratings and Thermal Characteristics@T<sub>A</sub>=25°C unless otherwise specified

Characteristic	Symbol	Value	Unit
Junction Temperature Range	T <sub>J</sub>	-55 to +175	°C
Storage Temperature Range	T <sub>STG</sub>	-55 to +150	°C
Typical Thermal Resistance Junction to Lead	R <sub>θJL</sub>	15	°C/W
Typical Thermal Resistance Junction to Ambient	R <sub>θJA</sub>	75	°C/W
Peak Pulse Power (with 10/1000µs waveform)	P <sub>PPM</sub>	1500	W

Note: 1. Non-repetitive current pulse, per Fig.3 and derated above Ta=25 °C per Fig.2.  
2. Mounted on Copper Pad area of 5.0x5.0 mm to each terminal.

### Ordering Information

Device	Package	Shipping
SMCJ200CA	SMC (Pb-Free)	3000pcs / reel
SMCJ200CATR	SMC (Pb-Free)	3000pcs / reel

For information on tape and reel specifications, including part orientation and tape sizes, please refer to our tape and reel packaging specification.

### Marking Diagram



Where XXXXX is YYWWL

BHV = Marking code  
YY = Year  
WW = Week  
L = Lot Number

**Cautions:** Molding resin  
Epoxy resin UL:94V-0

**Electrical Characteristics @  $T_A=25^\circ\text{C}$  unless otherwise specified**

Part Number	Marking code	Reverse Stand off Voltage $V_R$	Breakdown Voltage $V_{BR}$ (Volts) @ $I_T$		Test Current $I_T$	Maximum Clamping Voltage $V_C$ @ $I_{pp}$	Maximum Peak Pulse Current $I_{pp}$	Maximum Reverse Leakage $I_R$ @ $V_R$
		(Volts)	MIN.	MAX.	(mA)	(Volts)	(A)	( $\mu\text{A}$ )
SMCJ200CA	BHV	200.0	224	247	1	324.0	4.6	1

**Ratings and Characteristics Curves**

Figure 1 - Peak Pulse Power Rating Curve

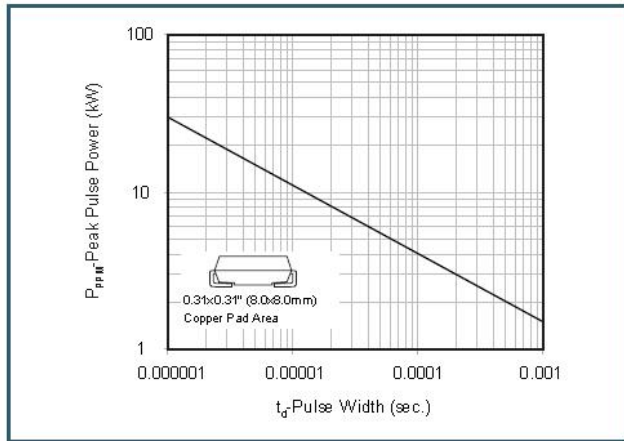

Figure 2 - Pulse Derating Curve

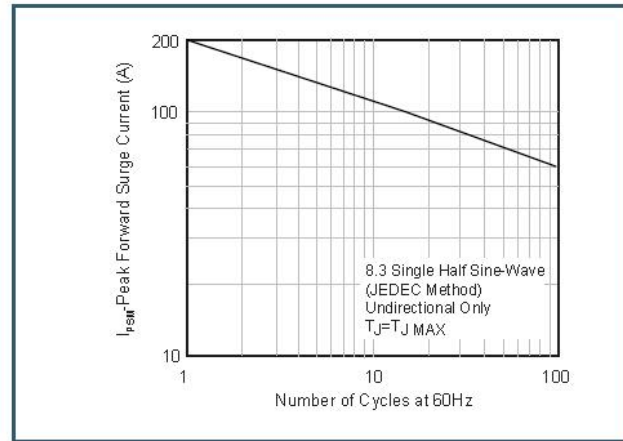

Figure 3 - Pulse Waveform

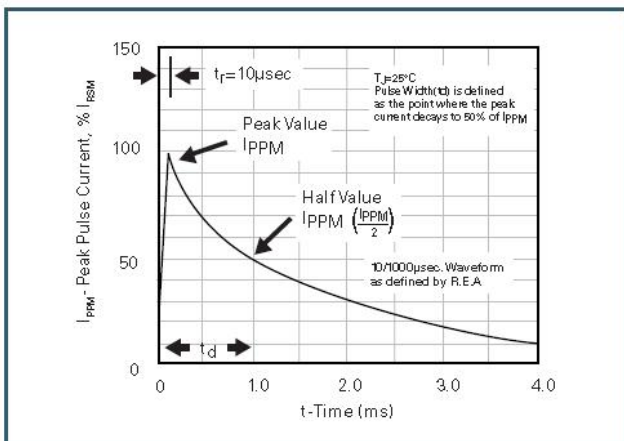

Figure 4 - Typical Junction Capacitance

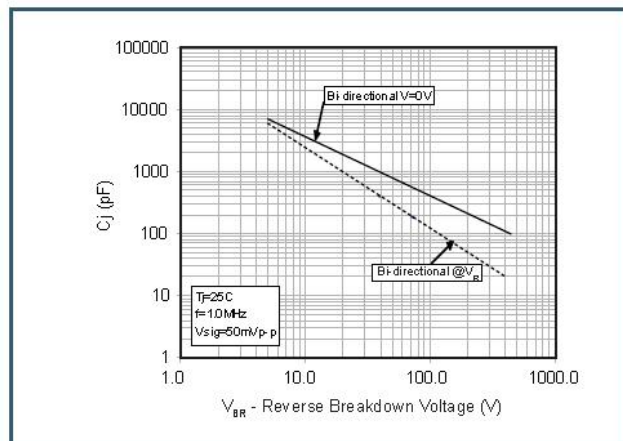
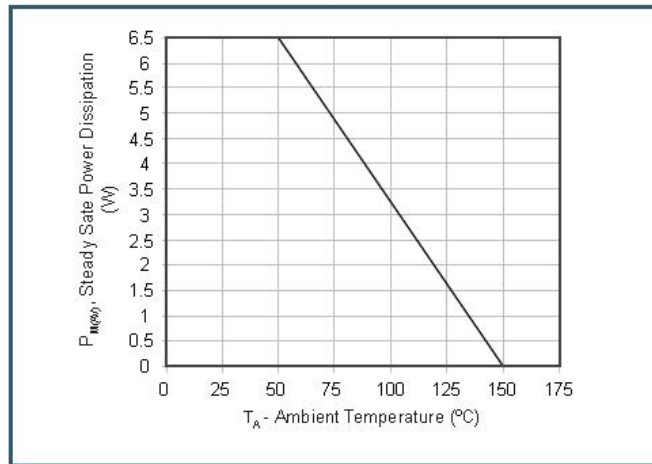
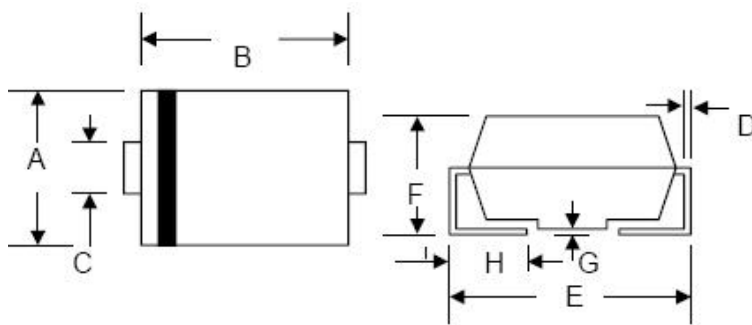

Figure 5 - Steady State Power Dissipation Derating Curve



**Mechanical Dimensions SMC**



Dim.	SMC			
	Min.	Max.	Min.	Max.
A	5.59	6.22	0.220	0.245
B	6.60	7.11	0.260	0.280
C	2.75	3.25	0.108	0.128
D	0.152	0.51	0.006	0.02
E	7.75	8.13	0.305	0.320
F	2.00	2.62	0.079	0.103
G	-	0.203	-	0.008
H	0.76	1.52	0.030	0.060
	In Millimeters		In inches	

**Carrier Tape Specification SMC**

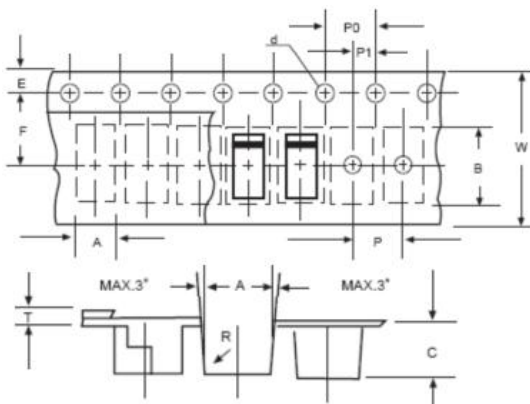

SYMBOL	Millimeters	
	Min.	Max.
A	5.90	6.10
B	8.20	8.40
C	2.40	2.60
d	1.40	1.60
E	1.40	1.60
F	7.60	7.70
P	7.90	8.10
P0	3.90	4.10
P1	3.90	4.10
T	-	0.600
W	15.80	16.20



**DISCLAIMER:**

- 1- The information given herein, including the specifications and dimensions, is subject to change without prior notice to improve product characteristics. Before ordering, purchasers are advised to contact the SMC Diode Solutions sales department for the latest version of the datasheet(s).
- 2- In cases where extremely high reliability is required (such as use in nuclear power control, aerospace and aviation, traffic equipment, medical equipment, and safety equipment), safety should be ensured by using semiconductor devices that feature assured safety or by means of users' fail-safe precautions or other arrangement.
- 3- In no event shall SMC Diode Solutions be liable for any damages that may result from an accident or any other cause during operation of the user's units according to the datasheet(s). SMC Diode Solution assumes no responsibility for any intellectual property claims or any other problems that may result from applications of information, products or circuits described in the datasheets.
- 4- In no event shall SMC Diode Solutions be liable for any failure in a semiconductor device or any secondary damage resulting from use at a value exceeding the absolute maximum rating.
- 5- No license is granted by the datasheet(s) under any patents or other rights of any third party or SMC Diode Solutions.
- 6- The datasheet(s) may not be reproduced or duplicated, in any form, in whole or part, without the expressed written permission of SMC Diode Solutions.
- 7- The products (technologies) described in the datasheet(s) are not to be provided to any party whose purpose in their application will hinder maintenance of international peace and safety nor are they to be applied to that purpose by their direct purchasers or any third party. When exporting these products (technologies), the necessary procedures are to be taken in accordance with related laws and regulations..